

VOLKSWAGEN

AKTIENGESELLSCHAFT



Operating manual

Diagnostic box VAS 5581A



Revision	Date	Reason
V00	02.06.2021	First edition

Legal notice

Manufacturer

CAR-connect GmbH
Am Egelingsberg 8
38542 Leiferde, Germany
Phone: +49 (0) 5373 92197-0
Fax: +49 (0) 5373 92197-88

info@car-connect.cc
www.car-connect.cc

Reproduction

Reproduction or reprinting, whether in whole or in part, always requires the written permission of the manufacturer.

Copyright

TRANSLATION OF THE ORIGINAL OPERATING MANUAL

All rights reserved.

All text, images and graphics are subject to copyright and other intellectual property laws.

Copyright 2020 CAR-connect GmbH.

Image sources

Symbols for warnings, prohibitions, mandatory actions and standards are taken from publicly accessible sources, such as the Internet. CAD product images and product photos are provided by the manufacturer. Images showing the product in use are provided with a reference to the source.

Contents

LEGAL NOTICE	2
CONTENTS	3
INTRODUCTION	5
Preliminary information	5
Validity of the declaration of conformity	5
Manufacturer specifications	5
SAFETY	6
Warning levels	6
Important safety instructions	7
Safety functions	8
Emergency stop button	8
Intended use	9
Requirements for the target group	10
Duties of the operator	10
Additional documents	10
PRODUCT DESCRIPTION	11
Scope of delivery	11
Design	12
Diagnostic box VAS 5581A/16	12
Power supply cable VAS 622 007	13
Adapter cable VAS 5581A/11	14
Sets	14
Symbols and connections	15
Displays and controls	17
Displays	17
Controls	18
Pin assignments	18
Technical data	19
OPERATION	20
Preparations	21
Preparing the diagnostic box	21
Switching on the diagnostic box	22
Connecting the power supply / Charging battery packs	23
Using the LC display	24
Buttons	24
Control keys	24
Menu structure	26
Operating mode menu	26
Settings menu	27
Information menu	28

Contents

Operating modes	29
Soft bridge mode	29
Gateway mode	30
Hard bridge mode	31
Starting diagnostics	32
Connecting vehicle components	32
Activating power supply to the component	33
Configuring the connection	34
Closing the high-voltage relay	34
Setting the CAN termination resistor	35
Connecting the VC interface	35
Finishing diagnostics	36
Exiting diagnostics	36
Switching off the diagnostic box	36
Detaching the plug connections	37
Detaching the plug connection for the diagnostic cable (32-pin)	37
Cleaning	38
Storage and transportation	38
Disposal	38
Maintenance	39
Changing the Li-ion battery pack	39
HELP	43
Warranty	43
Customer service	43

Preliminary information

Read through this operating manual carefully before using the product.

The product is delivered with a USB stick containing the operating manual in various languages. You can find the current version and additional languages on our homepage.



There is a QR code on the product. You can scan this QR code with a device that is connected to the internet to go directly to the download area for your product.

A power supply from another manufacturer is included with the product. This has a separate operating manual.

All operating manuals are an essential part of the product and must be kept together with the product. If you sell or transfer ownership of the product, the operating manuals must be handed over to the new operator.

In addition to the operating manuals, all the relevant regulations for working with traction batteries in electric vehicles are binding. They include but are not limited to: instructions from the vehicle manufacturer and the operator, company-specific safety requirements and the latest engineering standards for working with electric vehicles.

Validity of the declaration of conformity

The declaration of conformity applies to the product described in the operating manual. Any changes, modifications or extensions shall void the declaration of conformity and the risk assessment.

Manufacturer specifications

CAR-connect GmbH



Since its founding, our company has focused on groundbreaking solutions for electromobility. CAR-connect develops and produces custom solutions for the automotive industry, repair shops and special vehicle fleets.

Our core business is developing and producing innovative high-voltage charging technology for electric vehicles. Our portfolio also includes measurement and diagnostic technology for the entire vehicle and battery analysis equipment.

With extensive experience in software and hardware development, CAR-connect is your dependable partner at every production stage, from prototyping to series production.

CAR-connect GmbH – Experience, Expertise and Innovation – MADE IN GERMANY

This safety chapter provides information about the following:

- The warning levels contained in this operating manual
- Important safety instructions for the product
- Intended use of the product
- Requirements for the target group

This operating manual is only valid for the following product:

Item number	See the “Sets” chapter.
Designation	Diagnostic box VAS 5581A

Warning levels

This chapter provides information about the warning levels used in this operating manual.

DANGER

Failure to observe the safety instructions **WILL** result in death or serious injury!

WARNING

Failure to observe with the safety instructions **CAN** result in death or serious injury!

CAUTION

Failure to observe the safety instructions **CAN** result in minor physical injury!

Important safety instructions

This chapter contains the safety instructions that must be observed when handling the product.



DANGER

Danger of fatal electric shock!

The electrical voltage in other systems is lethal and will cause death by electric shock!

- Do not use the product for measurements on utility power circuits!
- Never attempt to power other devices with the product!



WARNING

Danger of fatal electric shock!

The electrical voltage in high-voltage systems is lethal and can cause death by electric shock!

Liquids, condensation and high humidity can cause short circuits!

- Do not let the product come into contact with liquids!
- Use the product only in dry and enclosed spaces!



WARNING

Danger of fatal electric shock!

The electrical voltage in the product is dangerous and can cause serious injury or death from electric shock!

Defective and damaged products cannot guarantee protection against electrical voltage!

- Do not let the product come into contact with chemicals!
- Replace a defective or damaged product immediately!
- Never attempt to repair or tamper with the product!

Safety functions

Emergency stop button



WARNING

Danger due to impaired safety function!

Damage to the emergency stop button can impair the product's safety function!

- Check the function of the emergency stop button at regular intervals (see the "Pressing the emergency stop button" and "Maintenance" sections)!
- Make sure that the emergency stop button is always readily accessible!

The product is equipped with an emergency stop button. Pressing the emergency stop button immediately stops the following:

1. The power supply to the diagnostic box
2. The electrical connection to terminals 15, 30 and the pilot line and thus the electrical supply to the component being tested
3. Communication via the VC interface
4. The electrical connection to the universal power supply

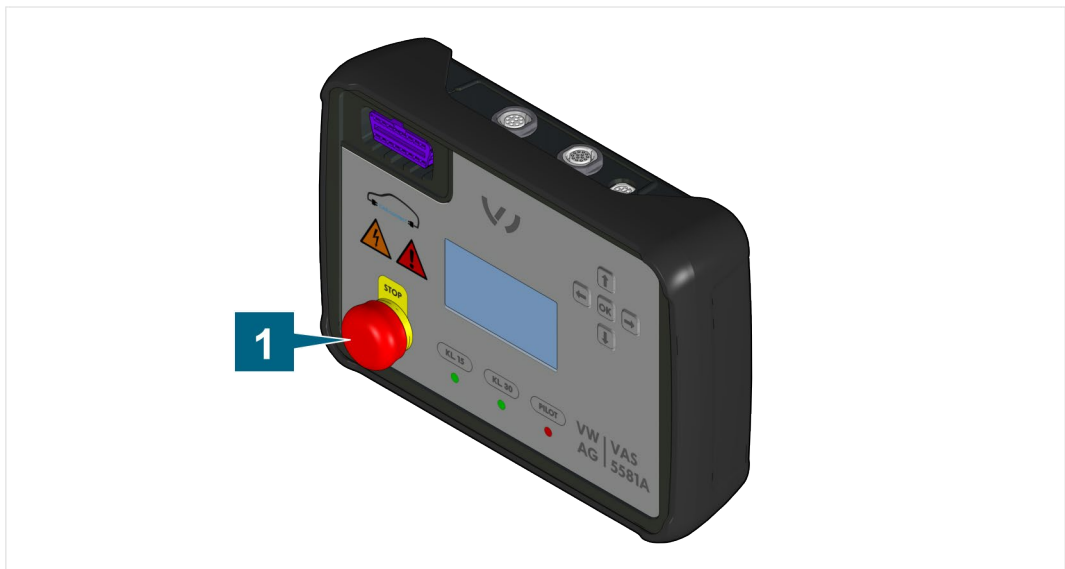

Position	Description
1	Emergency stop button

Pressing the emergency stop button

Push in the emergency stop button until it clicks into place.

- ✓ All electrical connections are immediately interrupted.

Resetting the emergency stop button

1. Switch off the diagnostic box at the main switch (see chapter “Switching off the diagnostic box”).
 2. Turn the emergency stop button clockwise and pull out until it clicks into place.
- ✓ Power supply to the diagnostic box is restored. You can now switch the diagnostic box on again (see chapter “Switching on the diagnostic box”).



If you press the emergency stop button, the current diagnostics will be interrupted and cannot be resumed. Error messages may appear in the diagnostic program.

Intended use

The diagnostic box is a tool for performing diagnostics on components outside the vehicle network (stand-alone components).

The diagnostic box supplies the power to the component and has an OBD port for establishing communication. This enables you to use diagnostic systems (e.g. ODIS Service in combination with VC interface VAS 6154) that usually access components via the OBD connector in the vehicle.

Depending on your requirements, the diagnostic system and the VC interface can communicate with the stand-alone component in three different operating modes:

- Soft bridge mode (SB)
- Gateway mode (GW)
- Hard bridge mode (HB)

Connect the diagnostic box to the vehicle component you want to test using adapter cables.

The diagnostic box can be updated, allowing it to be adapted to future applications with a firmware update. The diagnostic box is downward compatible with its predecessor the VAS 5581 and the corresponding adapter cables.

Use only the power supply belonging to the diagnostic box with the power supply cable suitable for the country of use, and use only the rechargeable batteries belonging to the diagnostic box (see chapters “Scope of delivery” and “Configuration”). Observe the operating manual from the manufacturer of the power supply! Use only the plug connections on the vehicle that the manufacturer has specified in the guided fault finding.

In this operating manual, vehicle manufacturers are exclusively defined as vehicle manufacturers in the Volkswagen Group.

Any use beyond what is listed here is prohibited.

Requirements for the target group

Only qualified personnel may work with this product!

In this operating manual, qualified personnel is defined as personnel meeting the requirements prescribed by the vehicle manufacturer for the Guided Fault Finding in the respective country of operation.

Duties of the operator

The operator is responsible for ensuring that all staff working with the diagnostic box fulfills the requirements for the target group.

Furthermore, the operator is responsible for ensuring the following:

- The diagnostic box is always in perfect working order.
- The regular inspection intervals for the diagnostic box are observed and recorded.

Additional documents

In addition to this document, the following documentation is also included with the product:

- Spare parts page, printed document 21.CC.2210.3063_ET
- Manufacturer's documentation for universal power supply

Scope of delivery

Immediately check the condition of the product and the completeness of the delivery. If anything is missing or defective, please contact the manufacturer immediately.



- (1) Carrying case
- (2) Diagnostic box VAS 5581A/16 with shock guard
- (3) Adapter cable VAS 5581A/11
- (4) Universal power supply VAS 5581A/10
- (5) Power supply cable (country-specific, see chapter “Power supply cable”)
- (6) USB stick with operating manual

Design

Diagnostic box VAS 5581A/16

Product design:

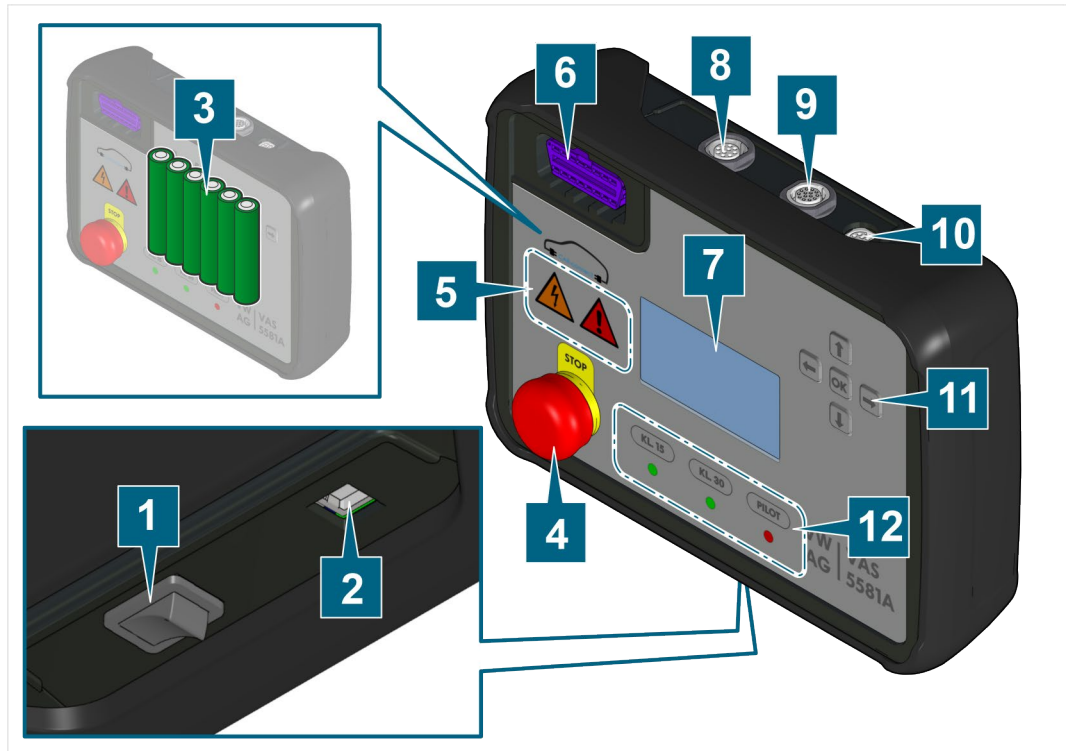

- (1) Main switch
- (2) USB 2.0 port (type B)
- (3) Li-ion battery pack VAS 5581A/9 (in the diagnostic box)
- (4) Emergency stop button
- (5) Warning indicators
- (6) OBD port
- (7) LC display
- (8) CAN port (A)
- (9) Ethernet/LIN port (B)
- (10) Power supply socket
- (11) Control keys
- (12) Status display

Power supply cable VAS 622 007

The product is delivered with a power supply cable suitable for the country of use. The ASE number in parentheses is for the power supply cable with the corresponding plug. The power supply cable has the following design, depending on the country of use:

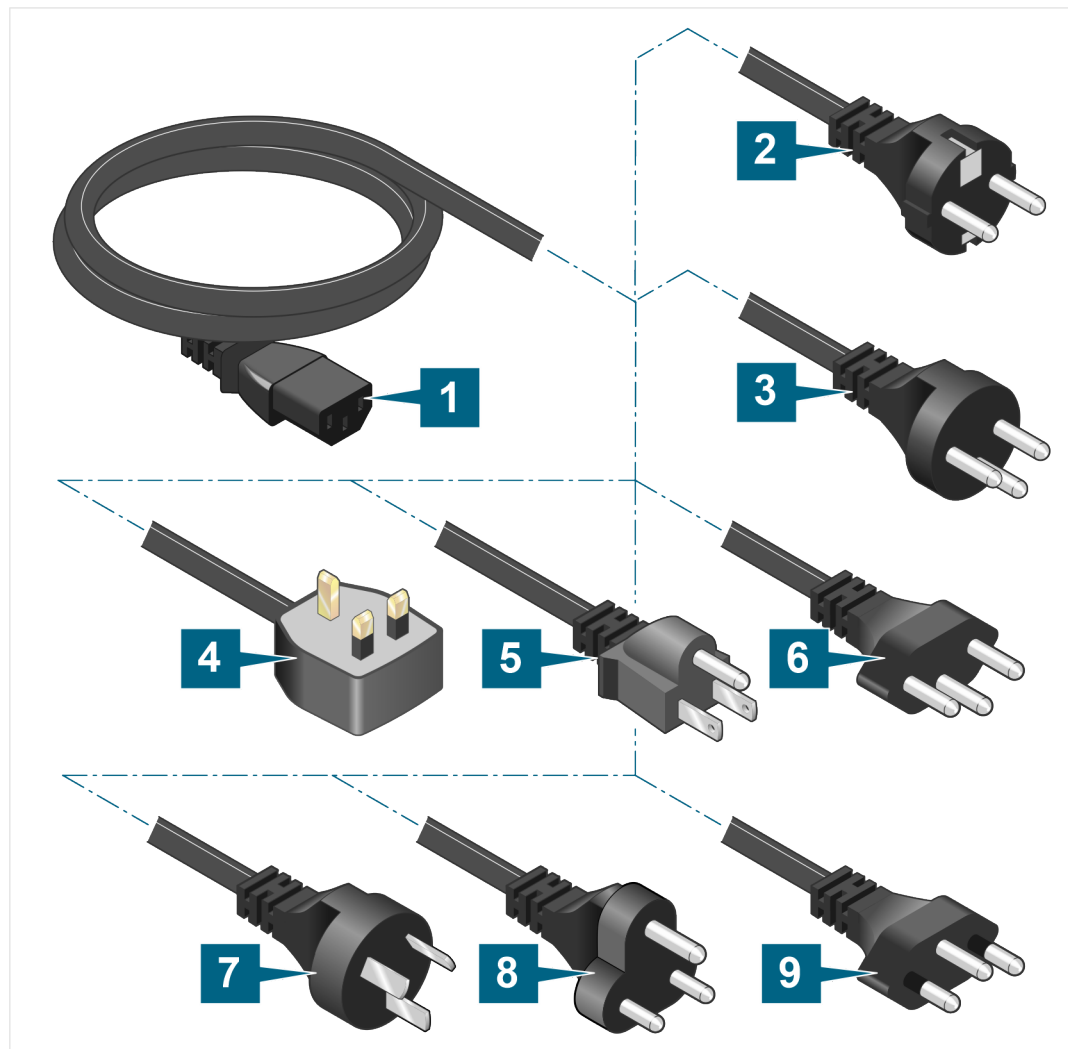

- (1) Power supply plug
- (2) Power supply plug type F (EU – ASE 622 007 00 000)
- (3) Power supply plug type H (IL – ASE 622 007 00 079)
- (4) Power supply plug type G (UK – ASE 622 007 00 020)
- (5) Power supply plug type B (USA – ASE 622 007 00 023/JP – ASE 622 007 00 070)
- (6) Power supply plug type J (CH – ASE 622 007 00 004)
- (7) Power supply plug type I (CN – ASE 622 007 00 074/AUS – ASE 622 007 00 026)
- (8) Power supply plug type M (ZA – ASE 622 007 00 030)
- (9) Power supply plug type N (BRA – ASE 622 007 00 066)

Adapter cable VAS 5581A/11



- (1) Ground clip
- (2) Low-voltage plug for MEB battery
- (3) Plug for diagnostic box

Sets

The diagnostic box is delivered as a set with a country-specific power supply cable. The following table shows the CC item numbers for the various sets.

CC item no.	Standard parts	Power supply cable	ASE number
22102608	<ul style="list-style-type: none"> • Diagnostic box VAS 5581A/16 • Shock guard • Adapter cable VAS 5581A/11 • Carrying case • Universal power supply • USB stick with operating manual 	Type F (EU)	409 040 71 000
22102871		Type J (CH)	409 040 71 004
22102872		Type G (UK)	409 040 71 020
22102873		Type B (US)	409 040 71 023
22102874		Type I (AUS)	409 040 71 026
22102875		Type M (ZAF)	409 040 71 030
22103066		Type N (BRA)	409 040 71 066
22103067		Type B (JP)	409 040 71 070
22103068		Type I (CN)	409 040 71 074
22103069		Type H (IL)	409 040 71 079









Symbols and connections

The product is equipped with the following stickers:



Position	Description	Function
1	Front sticker	The front sticker shows the displays and controls.
2	Nameplate	<p>The nameplate is located below the shock guard and contains the following information:</p> <ul style="list-style-type: none"> • Manufacturer information • Product type • Serial number • Year of manufacture • Degree of protection • Power supply specifications <p>You can use the serial number to track information relating to production.</p>
3	Port labels	<p>The following stickers identify the adjacent ports:</p> <ul style="list-style-type: none"> • A: CAN port • B: Ethernet/LIN port

The following symbols are shown on the product stickers:

Symbol	Meaning
	When this symbol is illuminated, it means the high-voltage relay to the vehicle component being tested is energized.
	When this symbol is illuminated, the diagnostic box is communicating without galvanic isolation.
	The serial number is used in conjunction with the manufacturer part number to identify the product.
22103063	The manufacturer part number is used in conjunction with the serial number to identify the product.
	Read the operating manual!
	The disposal instructions prohibit disposal of the product with household waste. Always dispose of the product in accordance with all local disposal regulations.
	This marking indicates that the product must not be operated outdoors.
	The CE marking certifies that the product complies with all applicable European regulations and has been subjected to the prescribed conformity assessment procedure.
	The test seal identifies the product as having been approved for use in workshops and production facilities belonging to the vehicle manufacturer.
	QR code for accessing the operating manual on mobile devices.

Displays and controls

The product is equipped with the following displays and controls:

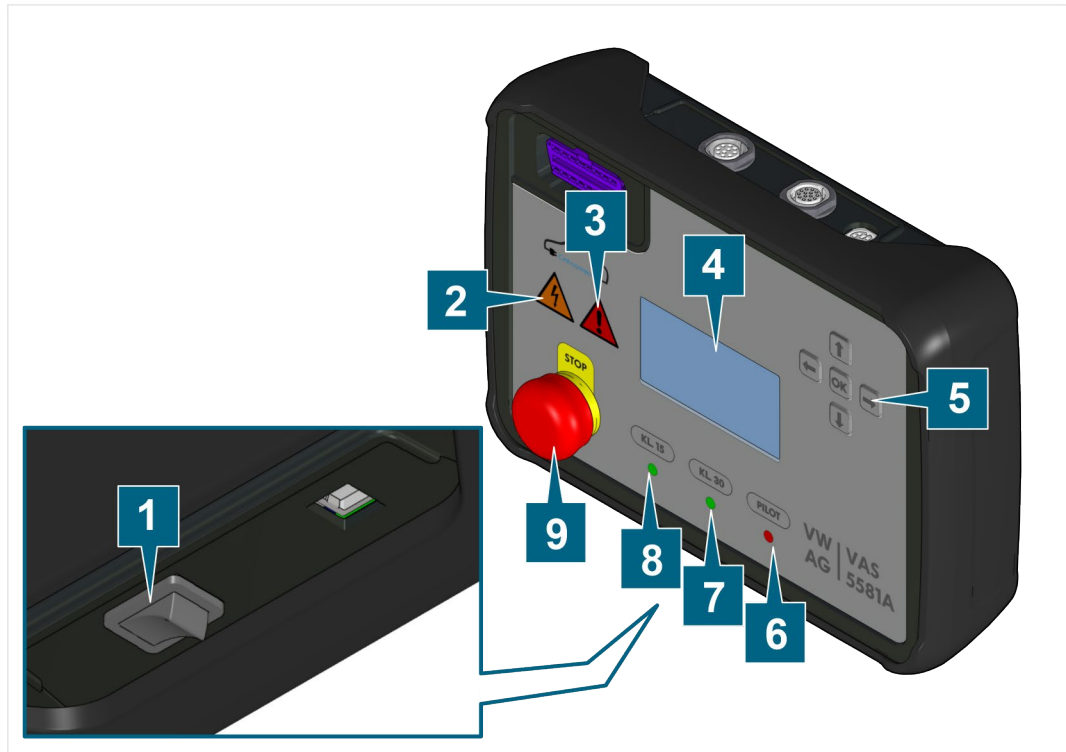

Displays

Position	Description	Function
2	High voltage warning light	Indicates that the high-voltage relay to the vehicle component being tested is energized.
3	Isolation warning light	Indicates that the diagnostic box is communicating without galvanic isolation.
4	LC display	<ul style="list-style-type: none"> • Display operating status • Control device functions • User interface to the diagnostic box
6	“Pilot” status indicator	LED illuminated: the pilot line is closed.
7	Terminal 30 status indicator	LED illuminated: power supply to terminal 30 (+ battery voltage) is active.
8	Terminal 15 status indicator	LED illuminated: power supply to terminal 15 (ignition) is active.

Controls

Position	Description	Function
1	Main switch	Switch the product on and off.
5	Control keys	Direction keys: navigate within functions. “OK” key: select or deselect functions.
9	Emergency stop button	Immediately interrupt the power supply. The exact function of the emergency stop button is described in the “Safety” section.

Pin assignments

Pin	CAN	Ethernet LIN	OBD
1	CAN 1 high	Ethernet TX +	Terminal 15 (ignition)
2	CAN 1 low	Activate Ethernet	—
3	CAN 2 high	Ethernet TX -	Ethernet TX +
4	CAN 2 low	Ethernet RX +	Terminal 31 (vehicle ground)
5	Terminal 15 (battery +)	Ethernet RX -	Terminal 31 (vehicle ground)
6	Terminal 31 (battery -)	LIN GND	CAN High (high-speed CAN)
7	Terminal 30 (battery +)	LIN VDD (power supply)	—
8	Terminal 30C (battery +)	LIN Signal	—
9	Pilot IN	Terminal 15 (battery +)	—
10	Pilot OUT	Terminal 31 (battery -)	—
11	—	Terminal 30 (battery +)	Ethernet TX -
12	—	Terminal 30C (battery +)	Ethernet RX +
13	—	Pilot IN	Ethernet RX -
14	—	Pilot OUT	CAN Low (high-speed CAN)
15	—	—	—
16	—	—	Terminal 30 (+ battery voltage)

Technical data

Rated data	Values
Manufacturer number	22103063
Input voltage	DC 18 – 24 V
Input current	Max. 2 A
Output voltage	DC 13.4 V
Output current	5 A
Batteries	6x Li-ion batteries, type 18650 (3000 mAh)
Battery voltage	DC 12.4 V
Degree of protection	IP20
Weight	With batteries: ~ 1070 g, without batteries: ~ 560 g
Dimension L/W/H	~ 220 mm/155 mm/65 mm

Ambient conditions	Operation	Storage/transport
Temperature	Charging: 0 °C to 45 °C Discharging: -20 ° to 60 °C	Max. 7 days: -20 °C to 65 °C Max. 3 months: -20 °C to 40 °C Max. 1 year: -20 °C to 25 °C
Relative humidity	35% to 85%	
	Condensation not permitted. Maximum permissible relative humidity: 60% in environments with corrosive gas/air.	

This section provides information about the following activities:

- Preparations
- Using the LC display
- Operating modes
- Starting diagnostics
- Finishing diagnostics
- Cleaning
- Storage
- Maintenance



WARNING

Danger of fatal electric shock!

The electrical voltage in other systems is lethal and can cause death by electric shock!

- Use the product only for the applications intended by the vehicle manufacturer!



CAUTION

Risk of damage!

Products can be damaged if they fall.

- Be sure never to throw or drop the product!
- Only use the product with the included shock guard!

Preparations

Preparing the diagnostic box

This chapter explains how to safely prepare the diagnostic box for operation.

Use the diagnostic box only with the supplied shock guard.

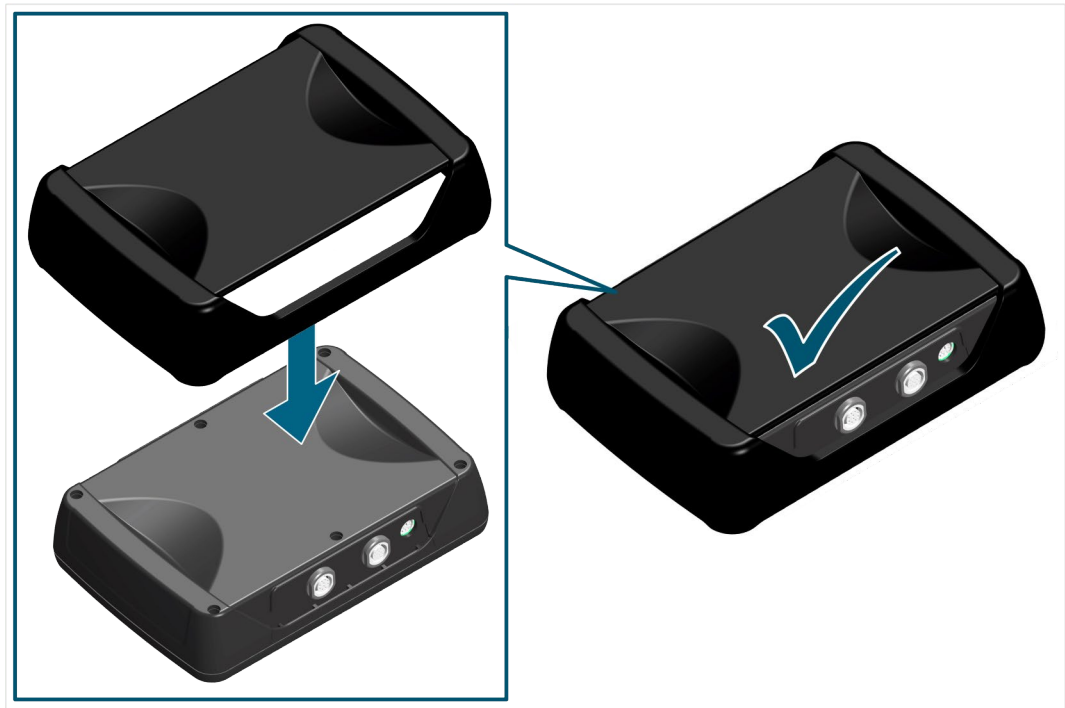

Pull the shock guard over the diagnostic box from below.

- ✓ The diagnostic box is now ready for operation.
- ✓ You can now switch on the diagnostic box.

Switching on the diagnostic box

This chapter explains how to switch on the diagnostic box and how to check the state of charge of the Li-ion battery pack.

Requirement: The diagnostic box must be ready for operation (see chapter “Preparing the diagnostic box”).

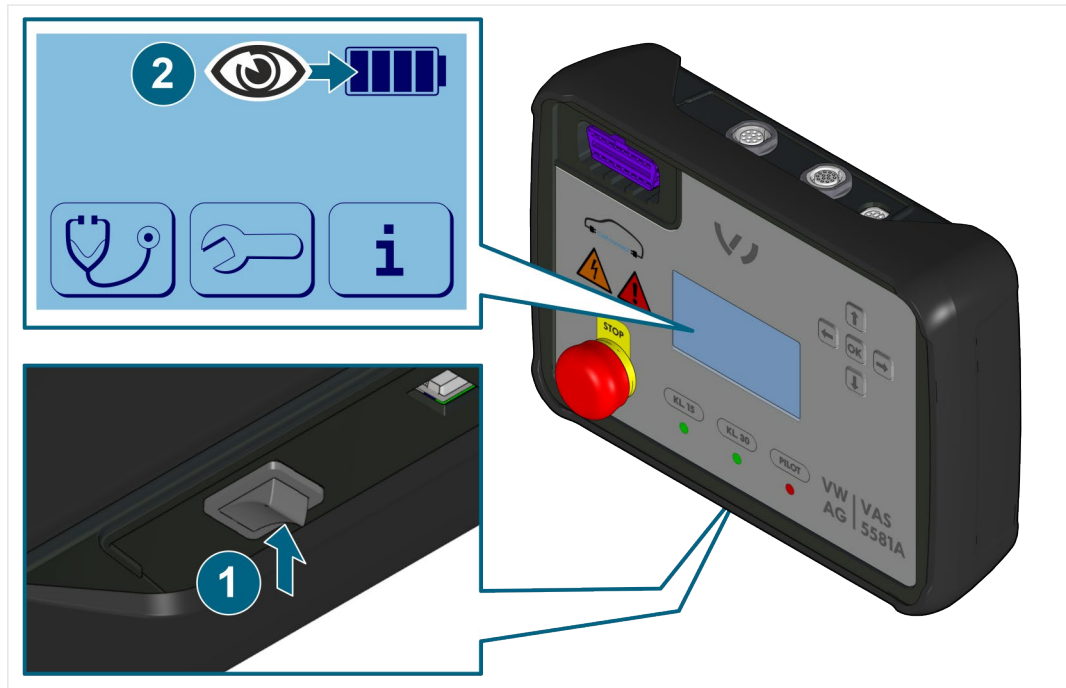

1. Switch on the diagnostic box using the main switch.
 - ⇒ The LC display shows the main menu, with the state of charge of the Li-ion battery pack displayed in the upper right corner.
2. Check the state of charge of the Li-ion battery pack.
 - ✓ The diagnostic box is now switched on.
 - ✓ Decide whether to connect the power supply (see chapter “Connecting the power supply/Charging the batteries”) and/or continue with operation (see chapter “Using the LC display”).

Connecting the power supply / Charging battery packs

If the power supply is connected, you can charge the Li-ion battery pack even when the diagnostic box is in operation. The charging time will be longer if you use the diagnostic box while it is charging.



The following illustration of the power supply plug and power socket is only an example and may differ from the equipment in your country.

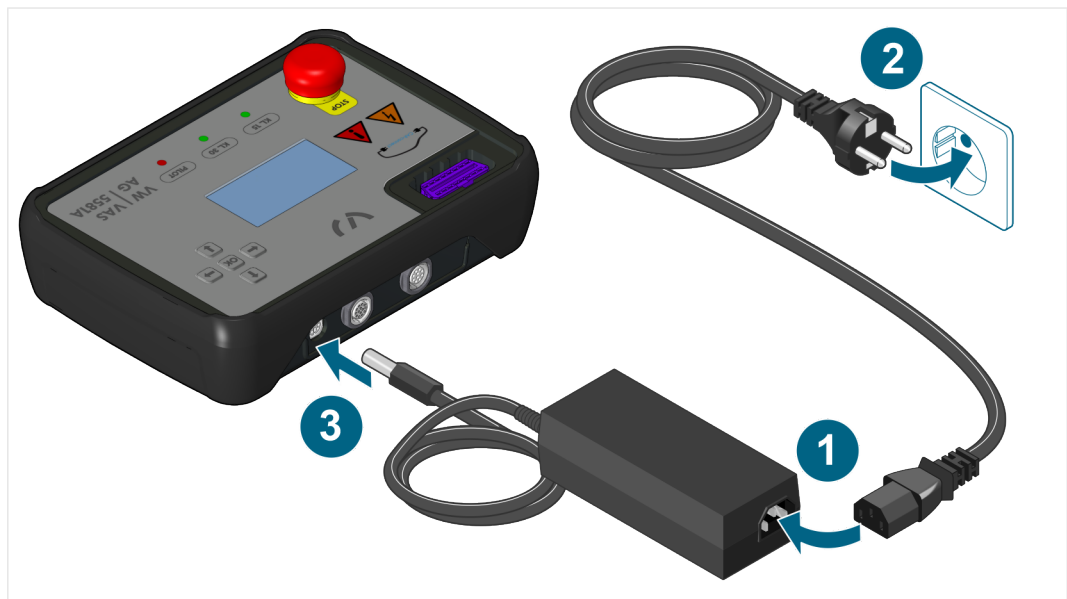

1. Plug the power supply connector into the power supply.
2. Plug the country-specific power supply plug into the power socket.
3. Connect the power supply to the power supply socket on the diagnostic box.

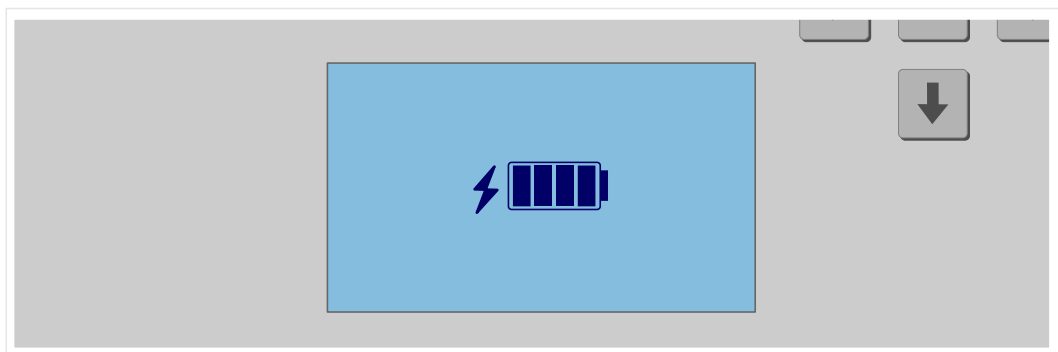





- ⇒ The display indicates that the Li-ion battery pack is charging.
- ✓ The power supply is now connected and the Li-ion battery pack is charging.

Using the LC display

Buttons

The diagnostic box's menus are composed of individually selectable buttons.

The buttons in the various menus can assume the following states:

State	Meaning
	You can highlight this button using the direction keys.
	You cannot highlight this button.
	The button is highlighted and you can activate its function by pressing the OK key.
	The button is highlighted and its function is active. You can deactivate its function by pressing the OK key.

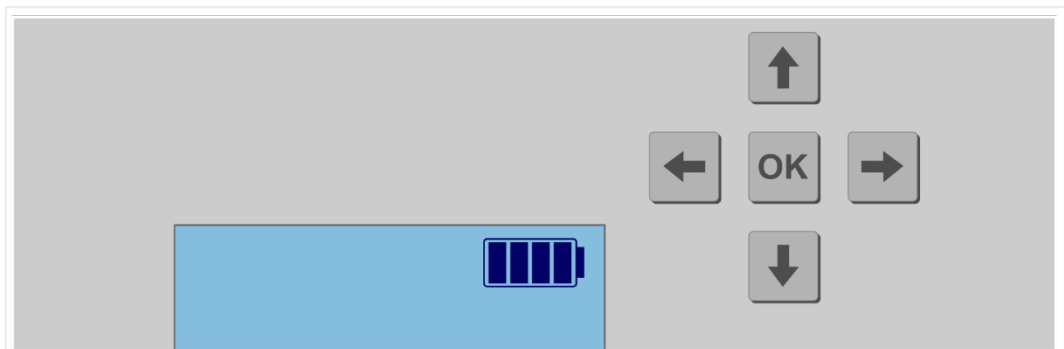

Control keys

The control keys are located to the upper right of the LC display.

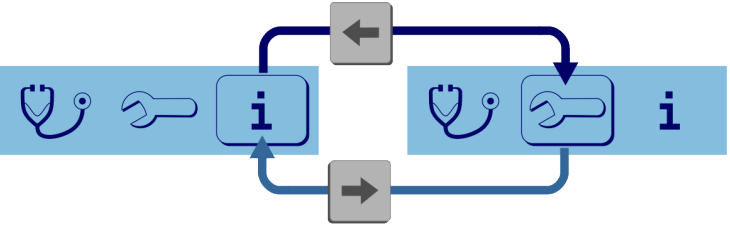

You can use the control keys to navigate through the menu on the LC display, make settings and change parameters.

The control keys have the following functions:

Control key	Function
	<p>Use the direction keys to highlight individual menu items or information pages.</p> <p>In the main menu/settings menu/operating mode menu: Pressing a direction key moves the cursor on the LC display by one button in the direction pressed.</p>  <p>In the information menu: You can scroll through the information pages by pressing the up and down direction keys.</p>
	<p>You can use the OK key to select highlighted buttons or to activate/deactivate controllable functions.</p> <p>In the main menu: selects the highlighted button and opens the respective submenu.</p> <p>In the information menu: exits the information menu and goes back to the main menu.</p> <p>In the settings menu/operating mode menu: selects the highlighted button, which activates the corresponding function. A filled bar indicates that the function is active.</p>  <p>Pressing the OK key again deactivates the function.</p>

Menu structure

The figure below shows the menu structure and how you can navigate within it. The various information and parameters are described in the tables below.

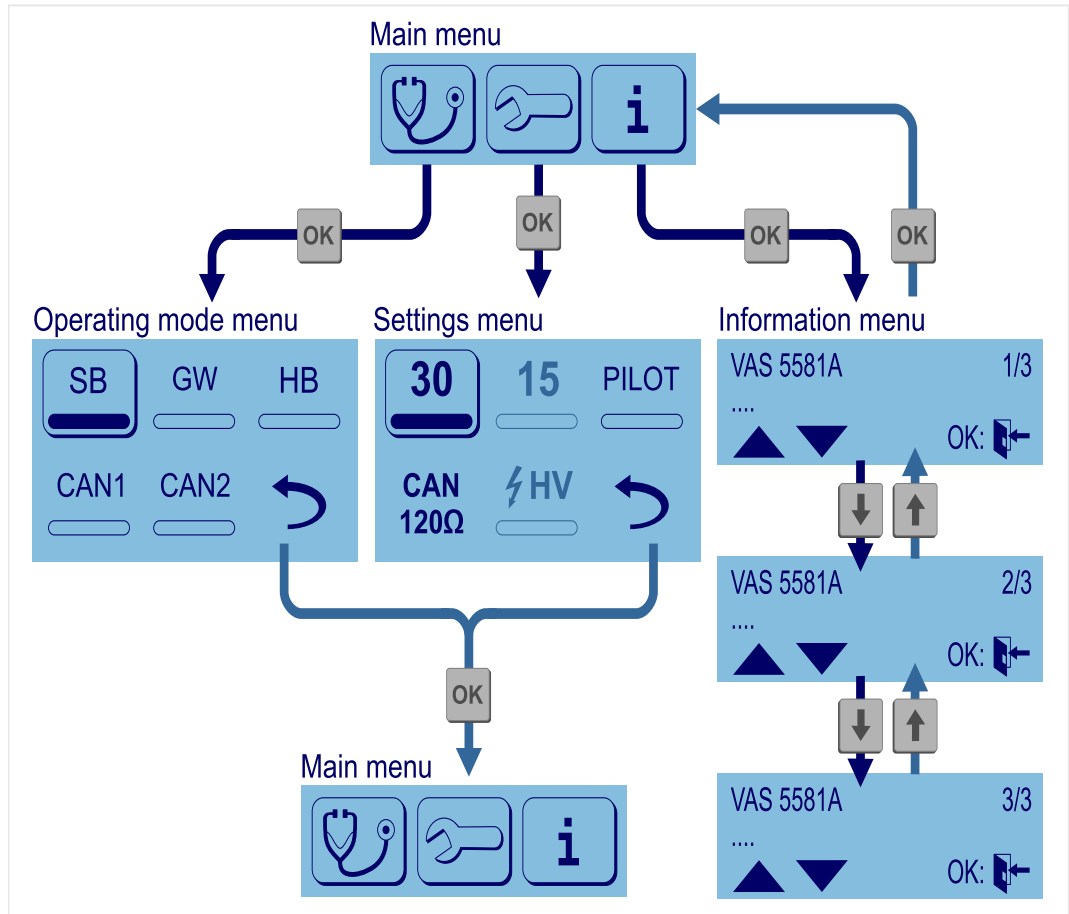





Operating mode menu

The operating mode menu shows the available operating modes and communication protocols. The buttons are explained in the table below.

1. Scroll through the buttons by pressing the direction keys.
2. Select or deselect a highlighted button by pressing the OK key.







Button	Designation	Function
	Soft bridge mode	If this button is selected, the diagnostic box operates in soft bridge mode. The box communicates with the connected vehicle component via the microcontroller with galvanic isolation.
	Gateway mode	If this button is selected, the diagnostic box operates in gateway mode. The box communicates with the connected vehicle component via the microcontroller with galvanic isolation.

Button	Designation	Function
	Hard bridge mode	If this button is selected, the diagnostic box operates in hard bridge mode. The box communicates with the connected vehicle component via a direct electrical connection to the OBD socket without galvanic isolation.
	CAN input 1	If this button is selected, CAN input 1 is available at the diagnostic box's OBD socket.
	CAN input 2	If this button is selected, CAN input 2 is available at the diagnostic box's OBD socket.
	Back	Selecting this button exits the operating mode menu and displays the main menu.

Settings menu

In the settings menu, you can activate power supply to the vehicle component to be tested, close the pilot line, close the high-voltage relay and set the termination resistor. The buttons are explained in the table below.

1. Scroll through the settings by pressing the direction keys.
2. Select or deselect a highlighted button by pressing the OK key.

Button	Designation	Function
	Terminal 30	If this button is selected, terminal 30 (+ battery voltage) is connected.
	Terminal 15	If this button is selected, terminal 15 (ignition) is connected.
	Pilot line	If this button is selected, the pilot line to the vehicle component being tested is closed.
	High-voltage relay	If this button is selected, the high-voltage relay on the vehicle component being tested is energized.
	CAN termination resistor	Selecting this button switches its state to "CAN 120Ω" or "CAN ∞". In the "CAN 120Ω" state, the CAN termination resistor is set to 120 ohms. In the "CAN ∞" state, the termination resistor is set to infinite (i.e. nonexistent).
		
	Back	Selecting this button exits the operating mode menu and displays the main menu.

Information menu

The information menu displays current information about the diagnostic box and the Li-ion battery packs. The information is explained in the table below.

1. Scroll through the pages of information by pressing the up and down direction keys.
2. Exit the information menu and open the main menu by pressing the OK key.

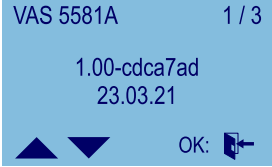
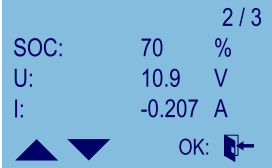
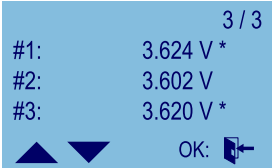
Display	Information	Meaning
	VAS 5581A/16	Designation of the diagnostic box.
	Line 1	Firmware version of the diagnostic box.
	Line 2	Date of the firmware version.
	SOC	SOC = "State of Charge," i.e. the charge level relative to the maximum capacity of the entire Li-ion battery pack.
	U	The current voltage of the entire Li-ion battery pack.
	I	The momentary current flow of the entire Li-ion battery pack. A negative sign means that the Li-ion battery pack is discharging.
	Cell voltages	Shows the voltages of the individual cells #1 to #3. An asterisk after a cell voltage indicates that cell balancing is currently taking place.

Operating modes

You can operate the diagnostic box in the following modes:

- **Soft bridge mode**
- **Gateway mode**
- **Hard bridge mode**

The correct operating mode is specified by the vehicle manufacturer in the guided fault finding. The operating mode affects the communication between the vehicle component being tested and the diagnostic program.

The following chapters explain what the individual operating modes do and how to activate them.

Soft bridge mode

In soft bridge mode, the box communicates with the connected vehicle component via the microcontroller with galvanic isolation.

The diagnostic box behaves as follows:

- CAN 2.0 messages are relayed bidirectionally without conversion.
- If the vehicle component is addressed with a CAN FD message, CAN FD messages are also relayed bidirectionally.

Take the following steps to activate soft bridge mode:

1. In the main menu, use the direction keys to highlight the operating mode menu button and select it with the OK key.



2. In the operating mode menu, use the direction keys to highlight the “SB” button and select it with the OK key.



- ✓ If the selection bar in the button is filled in, the diagnostic box is operating in soft bridge mode.

Gateway mode

In gateway mode, the box communicates with the connected vehicle component via the microcontroller with galvanic isolation.

The diagnostic box behaves as follows:

- CAN 2.0 messages are relayed bidirectionally without conversion.
- CAN FD messages are not relayed.
- If an MEB battery is addressed with a CAN 2.0 message, the box carries out protocol switching.

Protocol switching:

Protocol switching enables you to perform diagnostics on MEB batteries even if the diagnostic program communicates using CAN 2.0 messages.

The diagnostic box converts ISOTP messages from the VC interface (CAN 2.0A/B transport path) into ISOTP messages (CAN FD transport path with identifier adapted accordingly) and relays them to the battery.

Conversely, ISOTP messages from the battery (which may have a DLC > 8) are received, segmented if necessary (if DLC > 8) and relayed to the VC interface (again with identifier adaption).

Take the following steps to activate gateway mode:

1. In the main menu, use the direction keys to highlight the operating mode menu button and select it with the OK key.



2. In the operating mode menu, use the direction keys to highlight the "GW" button and select it with the OK key.



- ✓ If the selection bar in the button is filled in, the diagnostic box is operating in gateway mode.

Hard bridge mode

In hard bridge mode, the box communicates with the connected vehicle component via a direct electrical connection to the OBD socket without galvanic isolation.

The diagnostic box behaves as follows:

- The vehicle component is connected to the OBD socket via a direct hardware connection; CAN 2.0 and CAN FD messages are relayed directly without conversion.

Take the following steps to activate this CAN bridge mode:

1. In the main menu, use the direction keys to highlight the operating mode menu button and select it with the OK key.



2. In the operating mode menu, use the direction keys to highlight the “*HB*” button and select it with the OK key.



- ✓ If the selection bar in the button is filled in, the diagnostic box is operating in hard bridge mode.

Starting diagnostics

Connecting vehicle components

This chapter describes how to connect the vehicle component you are testing to the diagnostic box.

1. Observe the safety instructions.



2. Connect the ground clip to a conductive part of the component's housing.
3. Connect the low-voltage plug to the disconnected socket of the MEB battery you want to test.
4. Fold the locking mechanism up until it clicks into place. This pulls the plug into the plug connection.
5. Press the lock button in (not required).

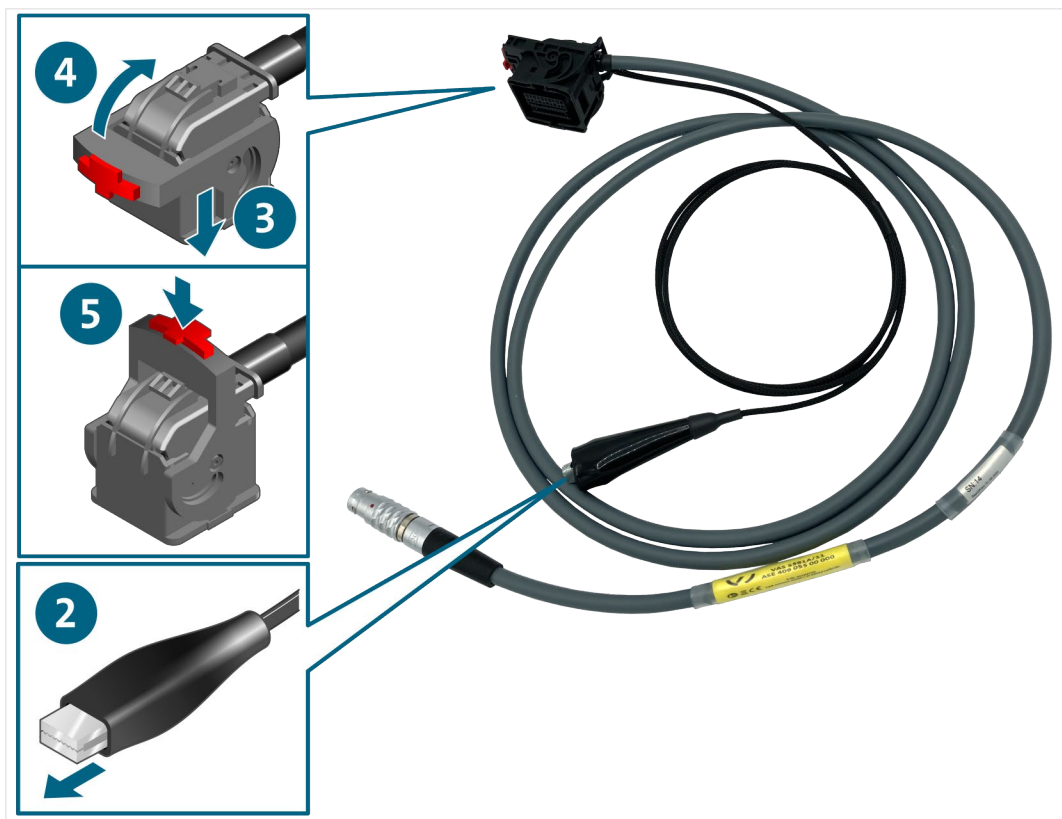

6. Connect the plug to the diagnostic box.

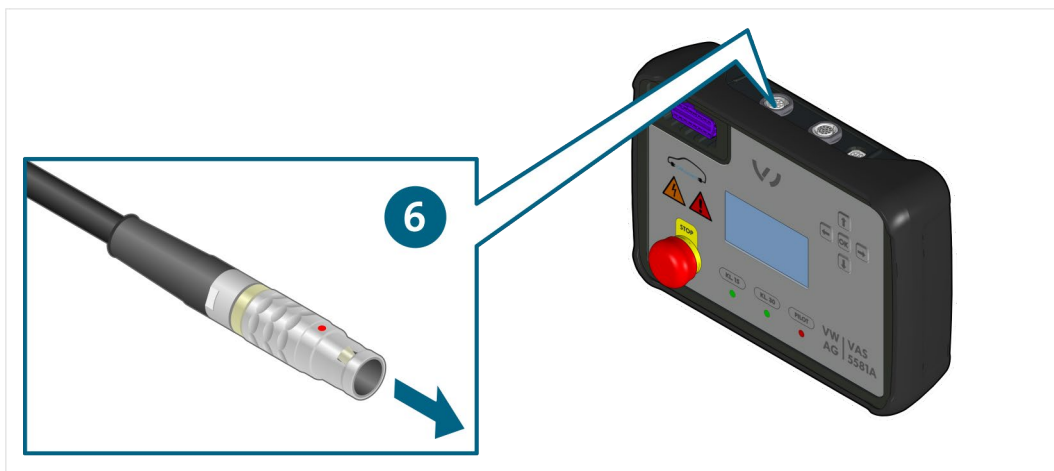

- ✓ You can now perform measurements in accordance with the guided fault finding.

Activating power supply to the component

To establish communication with the connected vehicle component, you must first supply the component with power. You must connect terminals 30 and/or 15, depending on the component. Connect terminals 30 and 15 when prompted to do so in the guided fault finding.

Requirements:

- The diagnostic box must be switched on (see chapter “Switching on the diagnostic box”).
 - The correct operating mode for the vehicle component must be selected (see chapter “Operating modes”).
 - The vehicle component must be connected to the diagnostic box (see chapter “Connecting the vehicle component”).
1. In the main menu, use the direction keys to highlight the settings menu button and select it with the OK key.



2. In the settings menu, use the direction keys to highlight the “30” button and select it with the OK key.



3. In the settings menu, use the direction keys to highlight the “15” button—if available—and select it with the OK key.



- ✓ The vehicle component is now supplied with power.

Configuring the connection

For certain components, further configuration is required to perform diagnostics. Do not perform the following steps unless prompted to do so in the guided fault finding.

Requirements:

- The vehicle component being tested must already be supplied with power (see chapter “Activating power supply to the component”).

Closing the pilot line

For certain components, it may be necessary to close the pilot line to perform diagnostics.

1. In the main menu, use the direction keys to highlight the settings menu button and select it with the OK key.



2. In the settings menu, use the direction keys to highlight the “Pilot” button—if available—and select it with the OK key.



- ✓ The pilot line is now closed.

Closing the high-voltage relay



WARNING

Danger of fatal electric shock!

The electrical voltage in high-voltage systems is lethal and can cause death by electric shock!

- Closing the high-voltage relay causes high-voltage circuits to become energized!
- Do not touch any live parts inside or outside the diagnostic box!
- Do not touch the poles on the high-voltage battery!

1. For certain components, it may be necessary to close the high-voltage relay to perform diagnostics.
2. In the main menu, use the direction keys to highlight the settings menu button and select it with the OK key.



3. In the settings menu, use the direction keys to highlight the “HV” button—if available—and select it with the OK key.



- ✓ The high-voltage relay is now closed.

Setting the CAN termination resistor

For certain components, it may be necessary to set the CAN termination resistor to 120 ohms or infinite in order to perform diagnostics.

1. In the main menu, use the direction keys to highlight the settings menu button and select it with the OK key.



2. In the settings menu, use the direction keys to highlight the “CAN 120Ω” or “CAN ∞” button and select it with the OK key.

⇒ The display switches to the other value.



- ✓ You have successfully set the CAN termination resistor.

Connecting the VC interface

To perform diagnostics on a vehicle component using the diagnostic program, the VC interface must be connected to the diagnostic box.

Requirement:

- The connection must be correctly configured (see chapter “Configuring the connection”).
3. Plug the VC interface into the OBD socket on the diagnostic box.

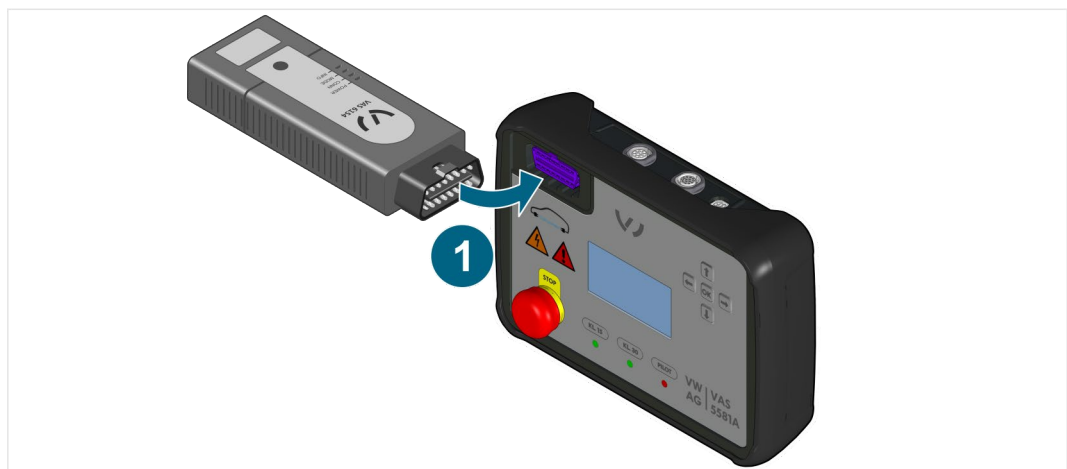

4. Set up the connection to the VC interface in the diagnostic program.
- ✓ You can now start diagnostics in the diagnostic program.

Finishing diagnostics

To avoid personal injury and property damage, always follow the sequence described below when quitting diagnostics. Always switch off the diagnostic box before disconnecting plug connections!

Exiting diagnostics

Before switching off the diagnostic box, you must quit diagnostics in the diagnostic program. Follow the instructions in the guided fault finding.

Switching off the diagnostic box

This chapter explains how to switch off the diagnostic box.

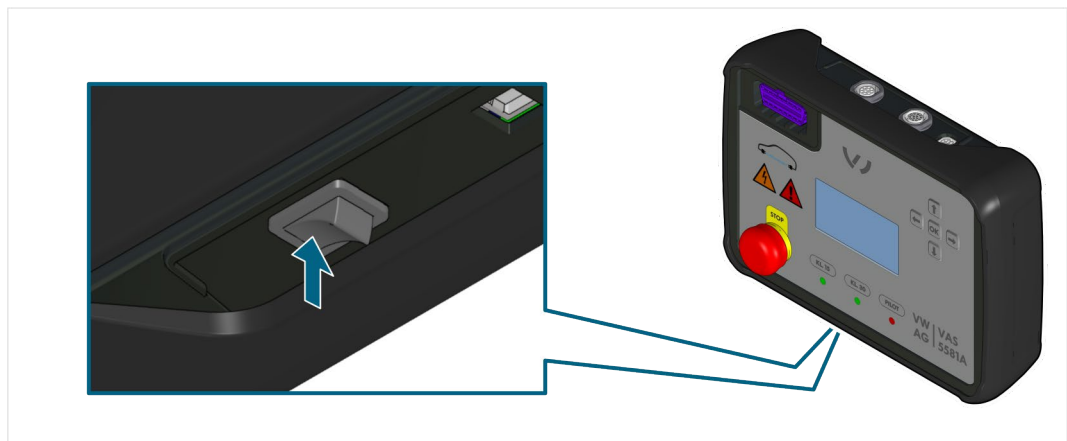

Switch off the diagnostic box using the main switch.

- ⇒ The information on the LC display disappears.
- ⇒ If previously closed, the high-voltage relay opens.
- ⇒ If previously closed, the pilot line is interrupted.
- ⇒ Power supply to the component being tested is interrupted.

Detaching the plug connections



WARNING

Risk of explosion!

Product components may produce sparks and electric arcs.

- Never disconnect plug connections while under load!
- Switch off the diagnostic box before disconnecting plug connections!
- Do not use the product in potentially explosive atmospheres!
- Ensure that the product is at least 50 cm above the ground during operation!

Detaching the plug connection for the diagnostic cable (32-pin)

The plug connections have a locking mechanism. To detach a plug connection:

1. Pull out the lock button.
2. Press down the latch and fold down the locking mechanism until it clicks into place. This releases the plug from the plug connection.
3. Pull the plug connection apart.

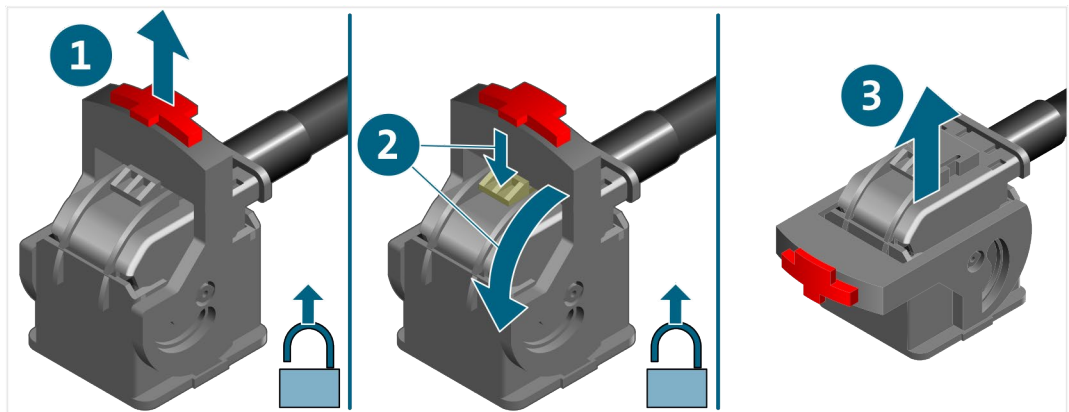

- ✓ The plug connection is now detached.

Cleaning



DANGER

Danger of fatal electric shock!

The electrical voltage in high-voltage systems is lethal and will cause death by electric shock!

- Disconnect the product from all power sources before cleaning the product!

Observe the safety instructions!

Use only a dry cloth to clean the product.

Storage and transportation

Store and transport the product only in the carrying case (see the “Scope of delivery” section).

Disposal

Observe the safety instructions!

Always dispose of the product in accordance with all local disposal regulations.

Maintenance

Observe the safety instructions!

National and local requirements for regular testing must be observed!

Test the product for proper function at intervals of no more than 24 months.

Contact the manufacturer to have a professional function test performed.



WARNING

Danger of electric shock!

The electrical voltage in the product is dangerous and can cause serious injury or death from electric shock!

- Always switch off the diagnostic box before performing maintenance work!
- Always disconnect the diagnostic box from all electrical lines before performing maintenance work!

Changing the Li-ion battery pack



WARNING

Risk of explosion!

The cells of the Li-ion battery pack are not protected against reverse polarity. Incorrect installation can cause the cells of the Li-ion battery pack to overheat and explode!

- When installing, make sure that the individual cells have the correct orientation!
- Do not short-circuit the cells and do not let the poles come into contact with conductive materials!
- Do not damage or remove the sheathing around the cells!
- Use only cells that have been approved by the manufacturer!
- Always replace all cells at the same time!

Observing the polarity of the battery cells

Since the cells of the Li-ion battery pack are not protected against reverse polarity, pay attention to the following when reinserting the individual cells:

- Follow the safety instructions!
- The cell's positive pole is the side with a groove running along the cell's circumference (see red marking in the figure below).
- The cells always have a pairwise orientation.
- There are "Plus (+)" and "Minus (-)" markings etched on the circuit board, though these may be hidden by wires or other structures.
- Use the main switch and the OBD socket as references when orienting the cells.

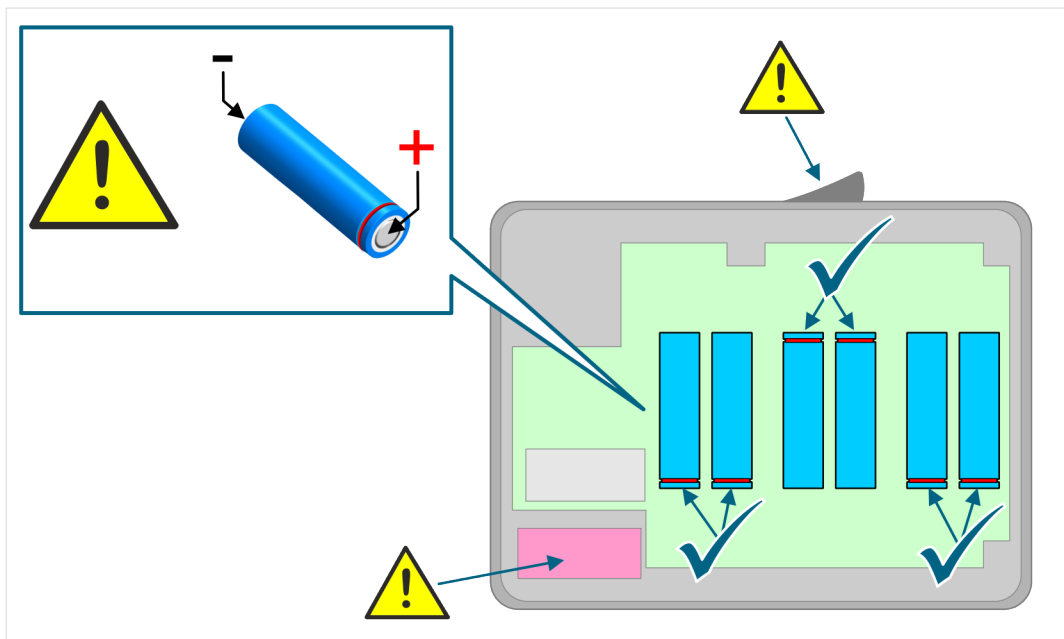

You must replace the Li-ion battery pack when it reaches its maximum service life or if it exhibits a fault.

Use only Li-ion battery packs that have been approved by the manufacturer!

1. Remove the shock guard from the diagnostic box.
2. Remove the screws on the reverse side.
3. Pull the lower shell off of the upper shell.

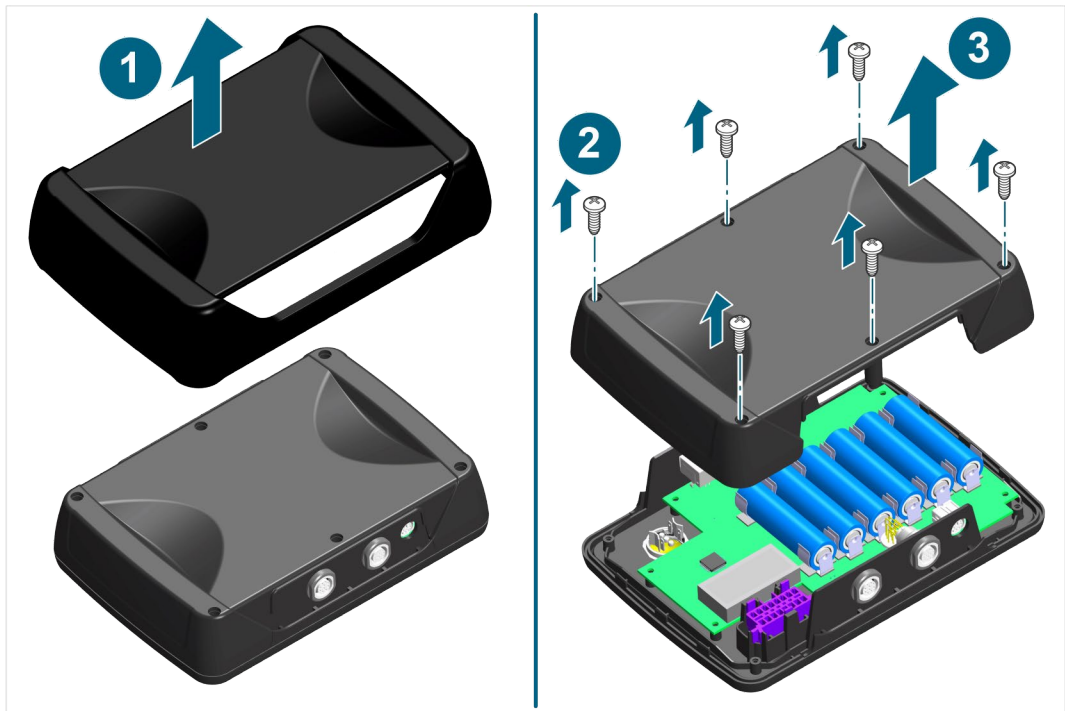

4. Lift each battery from the retaining clip at one end.
5. Pull the individual batteries completely out of the retaining clips.
6. Replace the faulty or used batteries with new ones.
7. Insert the new batteries into the retaining clips. Make sure the batteries have the correct orientation (see the chapter “Observing the battery polarity”)!

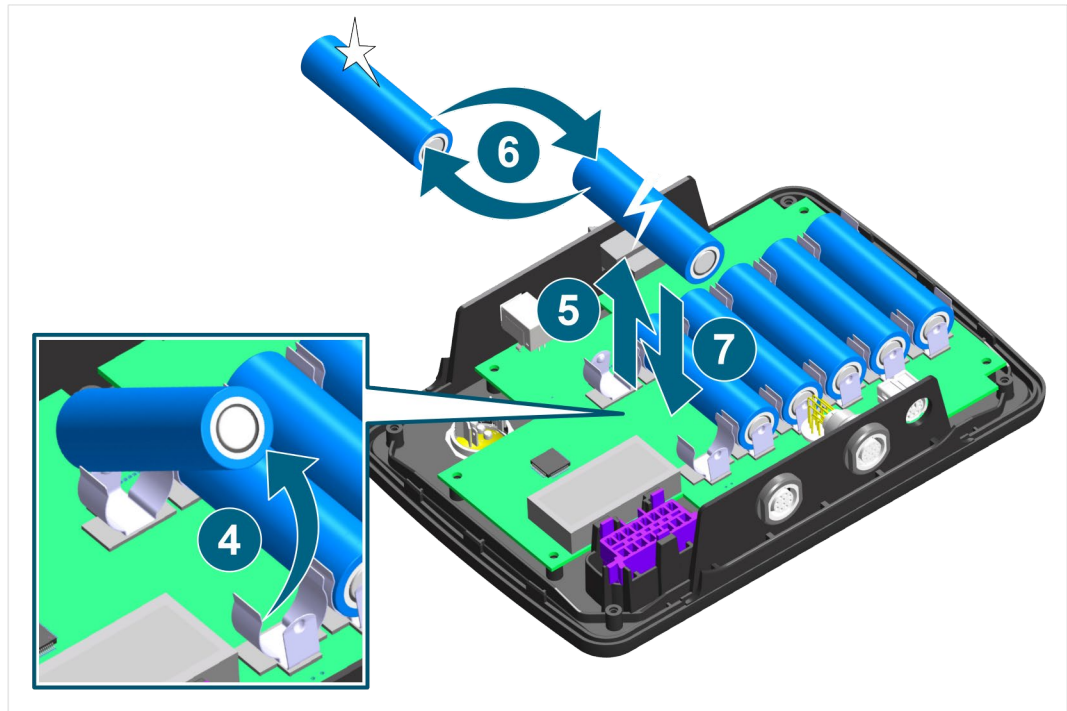

8. Replace the lower shell on the upper shell.
9. Attach the lower shell to the upper shell using the screws.
10. Pull the shock guard over the diagnostic box from below.

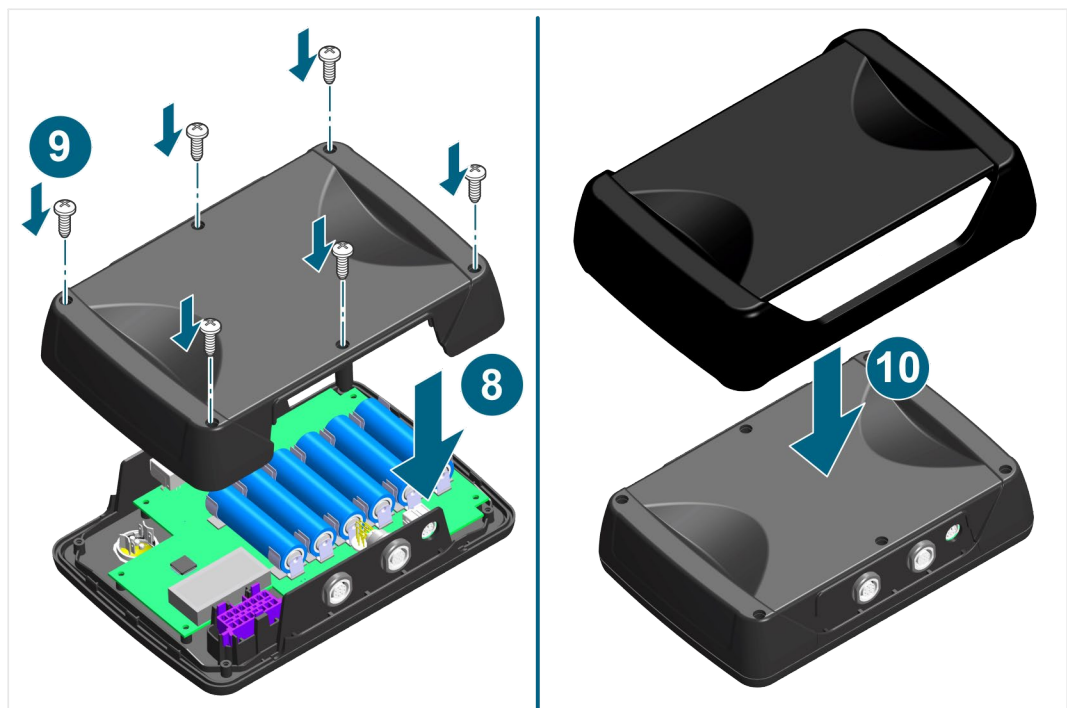

✓ You have now changed the Li-ion battery packs. The batteries may need to be charged.

Warranty

CAR-connect GmbH grants a warranty period of 24 months from the date of purchase. The warranty is valid for demonstrable defects in functional material and workmanship.

Further information on the warranty conditions can be found in the terms and conditions on the manufacturer's website.

Customer service

Always include the serial number with any product queries. This number is found on the product.

CAR-connect GmbH
Am Egelingsberg 8
38542 Leiferde, Germany

Phone: +49 (0) 5373 – 92197-0

Fax: +49 (0) 5373 – 92197-88

service@car-connect.cc

www.car-connect.cc

Volkswagen Aktiengesellschaft
K-GVO-LW
Group After Sales – Group Service
Literature and Systems
Repair Shop Equipment
PO box 011/4915
38442 Wolfsburg, Germany

For internal use only
Subject to technical changes
Edition 06 / 2021