

REP	REFERENCE	MASSE	NB	CT
10	2608.5510	2,61	1	
11	2608.5511	2,61	1	
12	2608.5512	1,87	1	
13	2608.5513	1,87	1	
14	2608.5514	1,50	1	
15	2608.5515	1,50	1	
16	2608.5516	0,05	2	
17	2608.5517	1,64	1	
18	2608.5518	1,64	1	
19	2608.5519	0,13	2	
CP.01	CP.01	0,02	2	
CP.02	CP.02	0,04	1	
VP.012	VP.012	0,03	2	
M5-40	7105X04003Z	0,01	2	
M6-30	7106X03003Z	0,01	4	
M8-40	7108X04003Z	0,02	2	
M10-20	7110X02003Z	0,02	2	
M5	910503Z	0,00	4	
E	CRM550.01	14,84	1	
R	KITCRM.01	1,00	1	
MRD.F.01	MRD.F.01	0,08	1	
	350M		1	
	AC.2608.8B		3	
	A659		1	
	2608.8B-EMB-A3		1	
	2608.8B-L04-A3		1	
	2608.8B-CTR		1	
	2608.8B-RP		1	
	INSTRUCTION-RVA4-1		1	

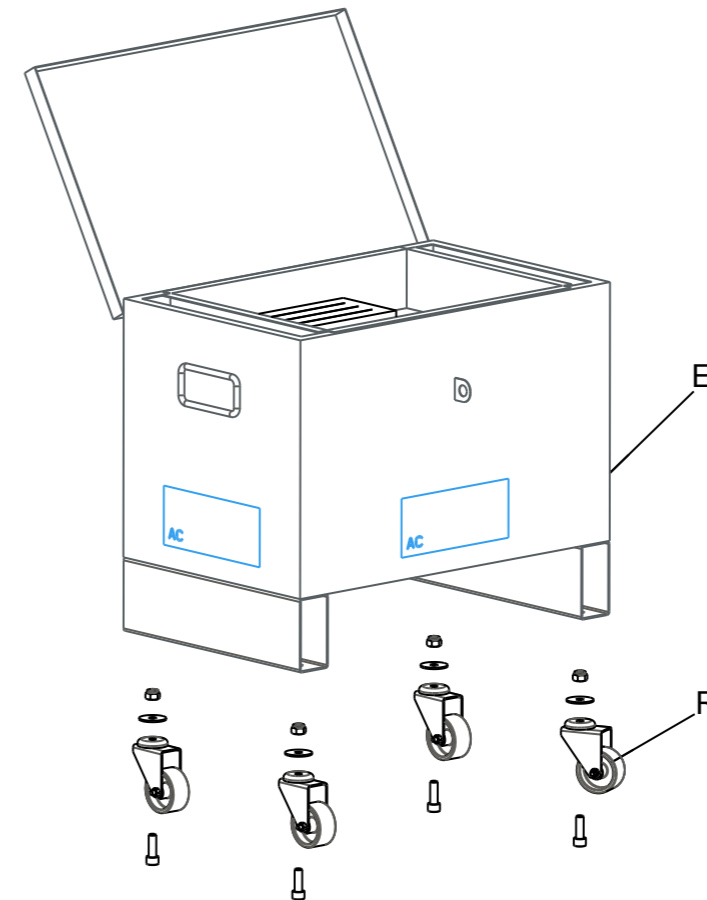

2608.8B-EMB-A3	31,8 KG	15-09-15	00
----------------	---------	----------	----

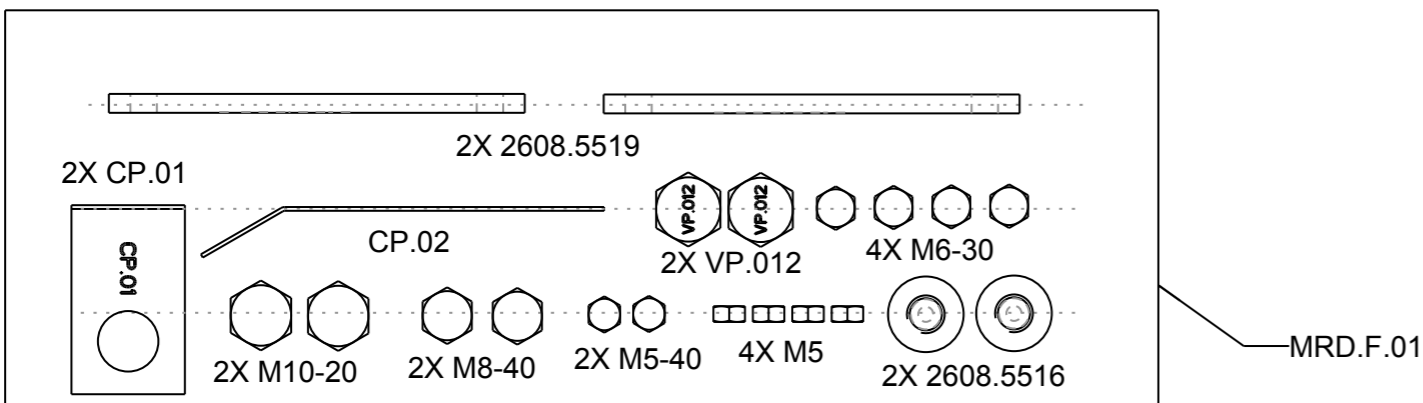
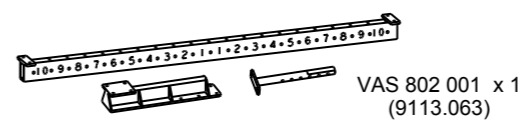
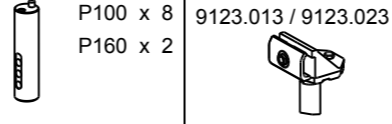
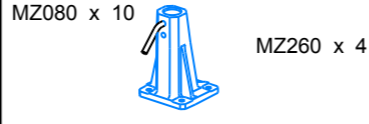
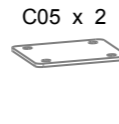
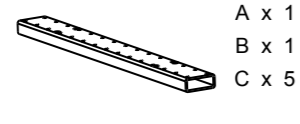

complément au
complementary set to
complemento al
Zusatz zu

VAS 801 003
(2608.5B)

REP	REFERENCE	NB		NB
10	2608.5510	1	M8-40	2
11	2608.5511	1		
CP.01	CP.01	2		
12	2608.5512	1		
13	2608.5513	1		
CP.02	CP.02	1		
VP.012	VP.012	2		

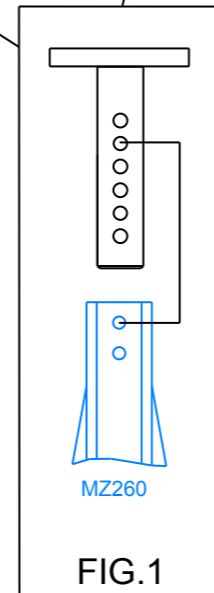
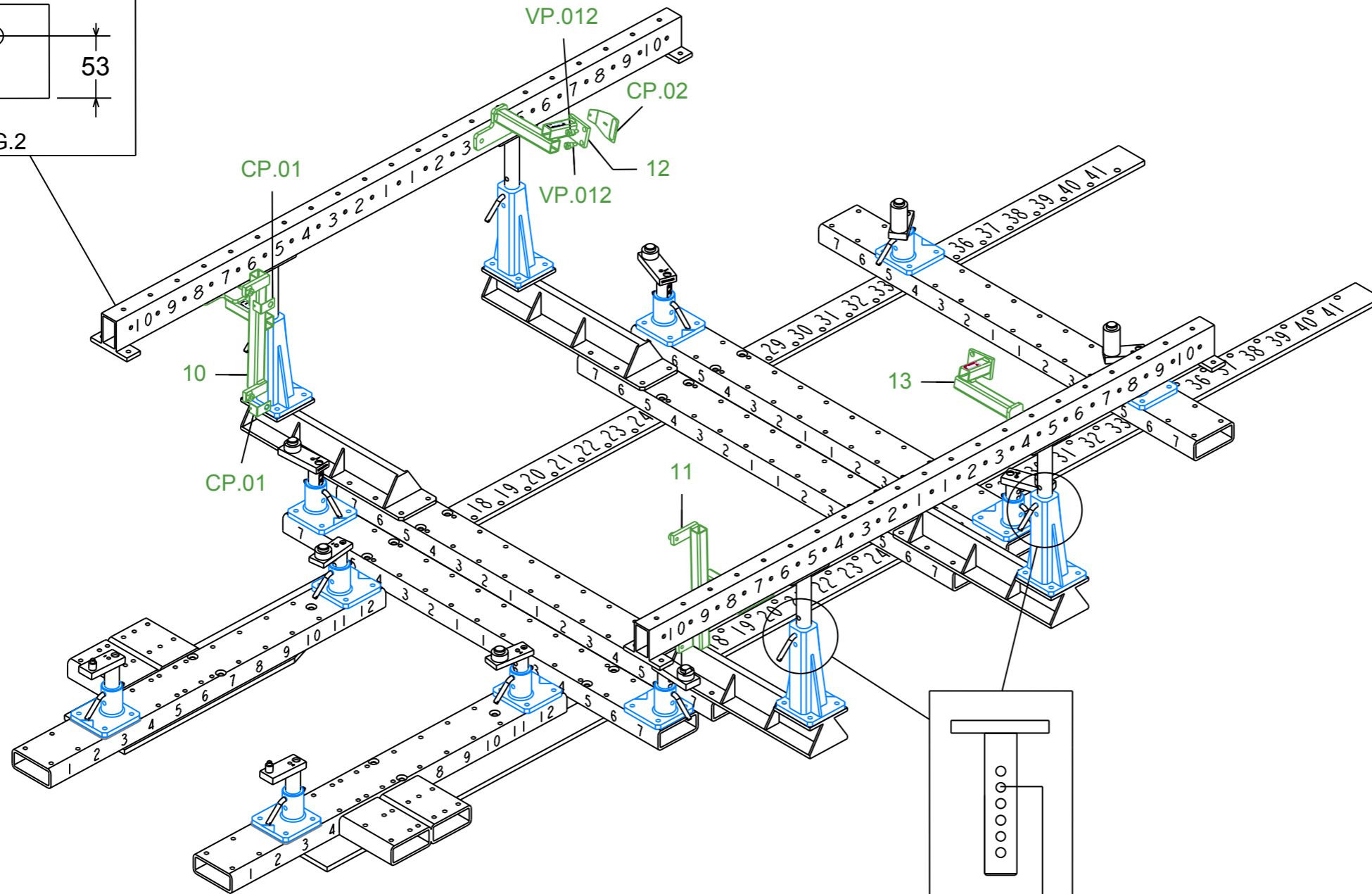
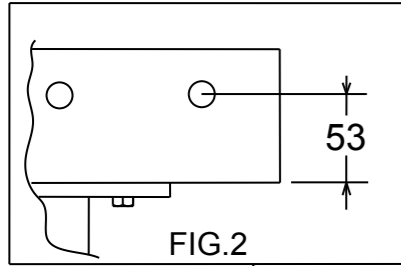

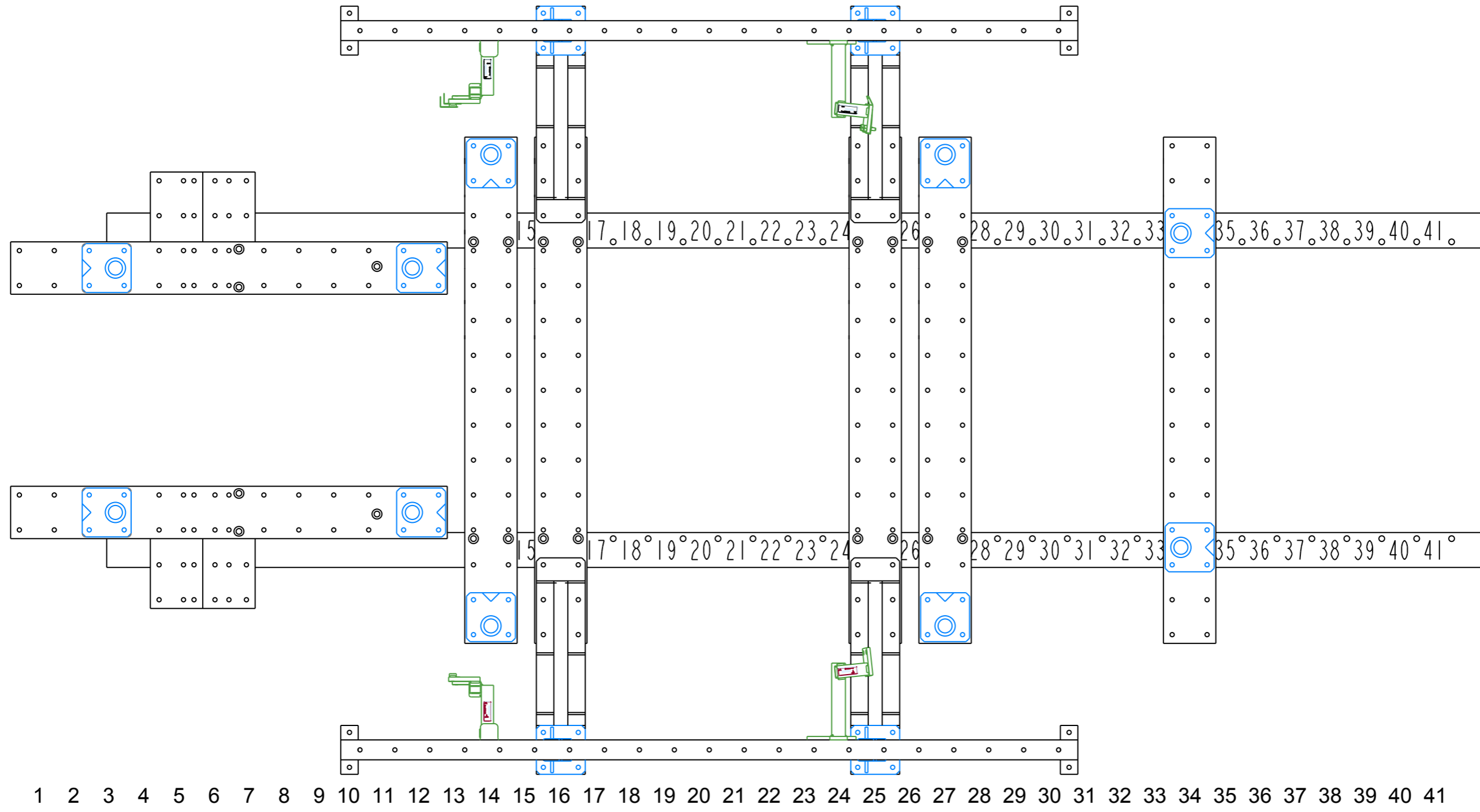

SEVENNE / GRIFFON / RHONE x 1



A x 1
B x 1
C x 5

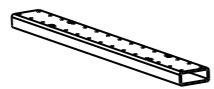

C05 x 2



MZ080 x 10



MZ601 x 2
MZ602 x 2



P100 x 8
P160 x 2

9123.013 / 9123.023

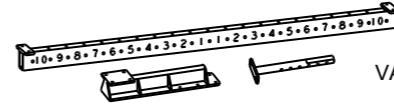

VAS 802 001 x 1
(9113.063)

complément au
complementary set to
complemento al
zusatz zu

VAS 801 003
(2608.5B)

REP	REFERENCE	NB				NB
14	2608.5514	1	M10-20			2
15	2608.5515	1	M5			4
16	2608.5516	2	M5-40			2
17	2608.5517	1	M6-30			4
18	2608.5518	1				
19	2608.5519	2				

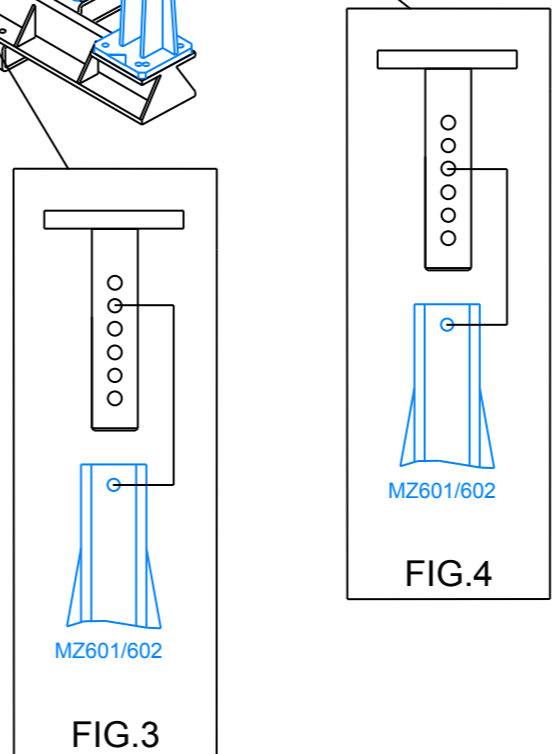
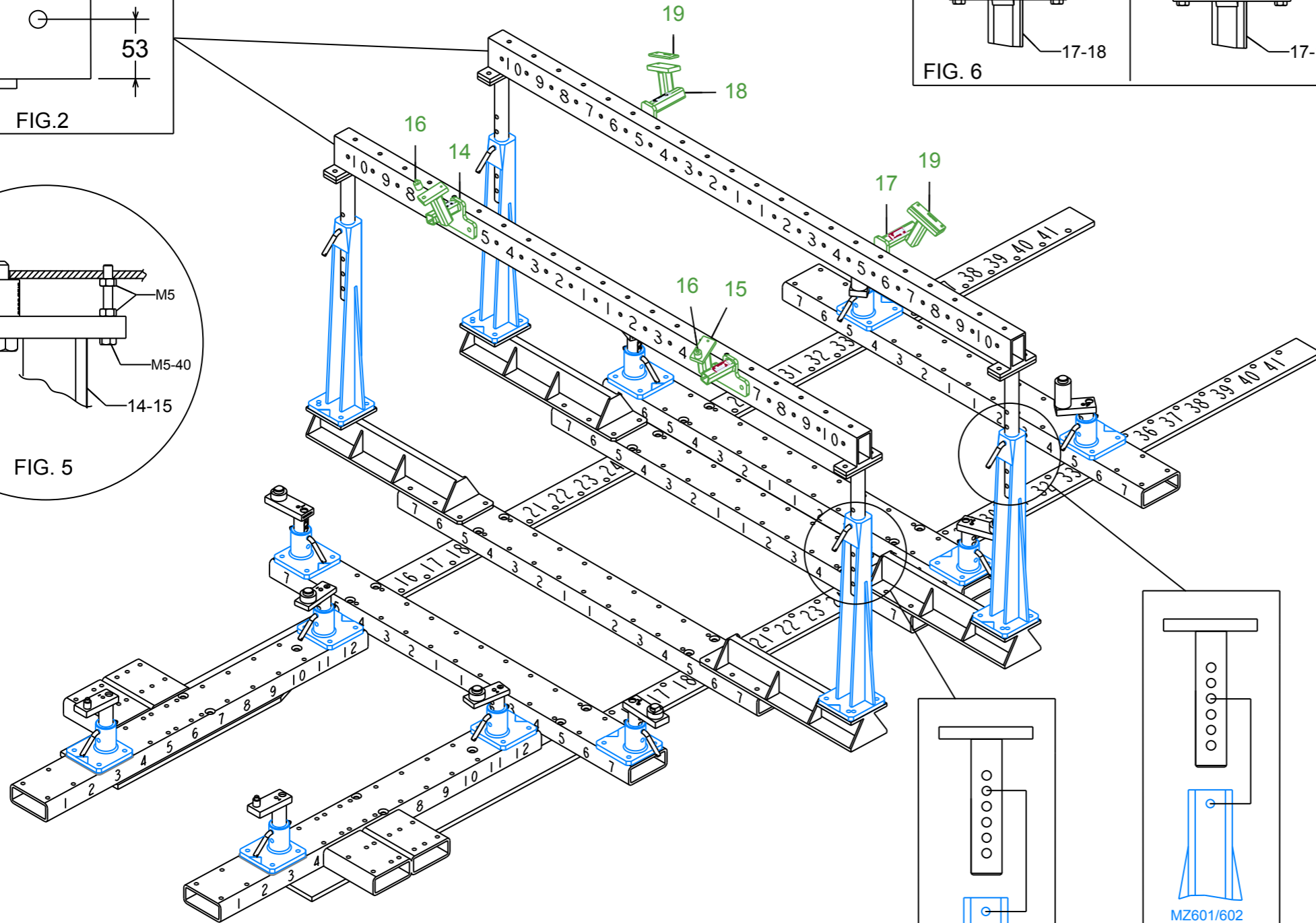
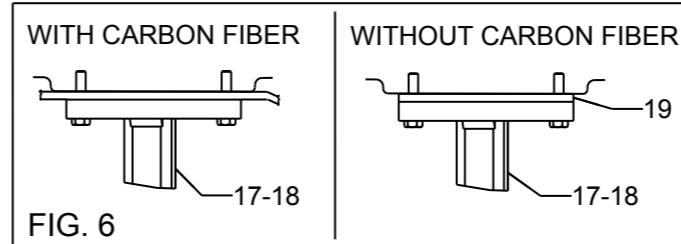
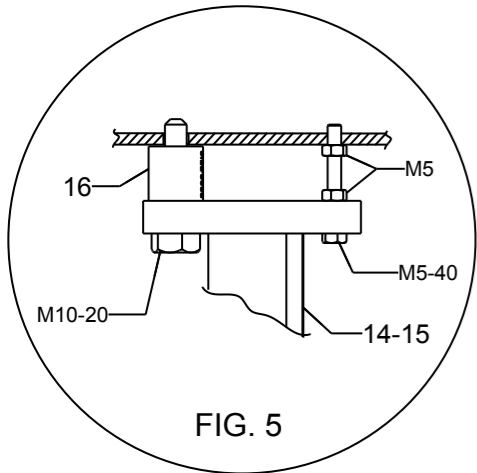
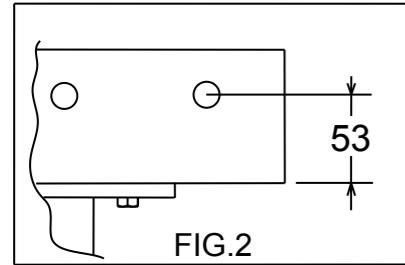

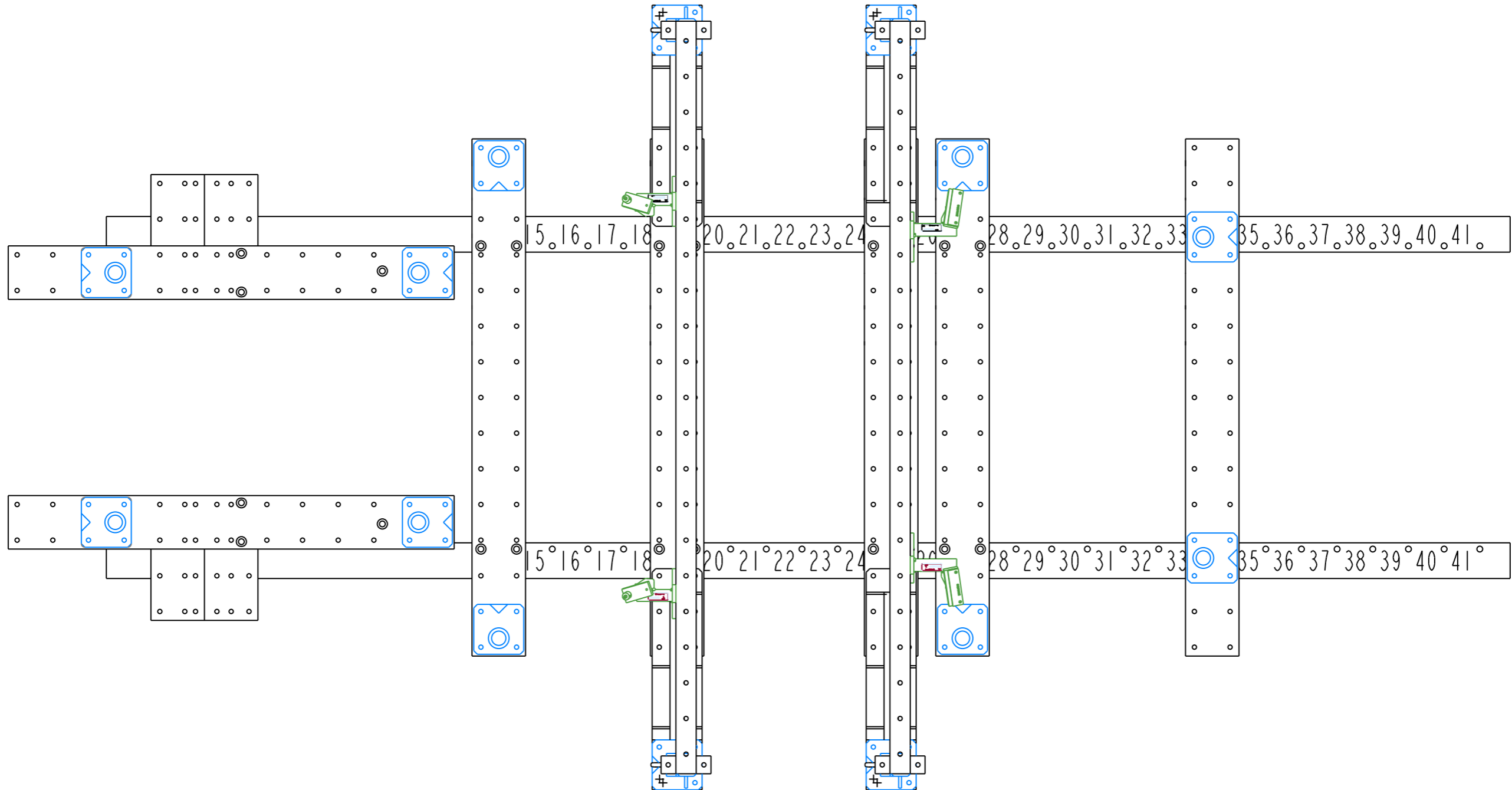

1 2 3 4 5 6 7 8 9 10 11 12 13 14 15 16 17 18 19 20 21 22 23 24 25 26 27 28 29 30 31 32 33 34 35 36 37 38 39 40 41

